

Swing Module

# Swing Module™

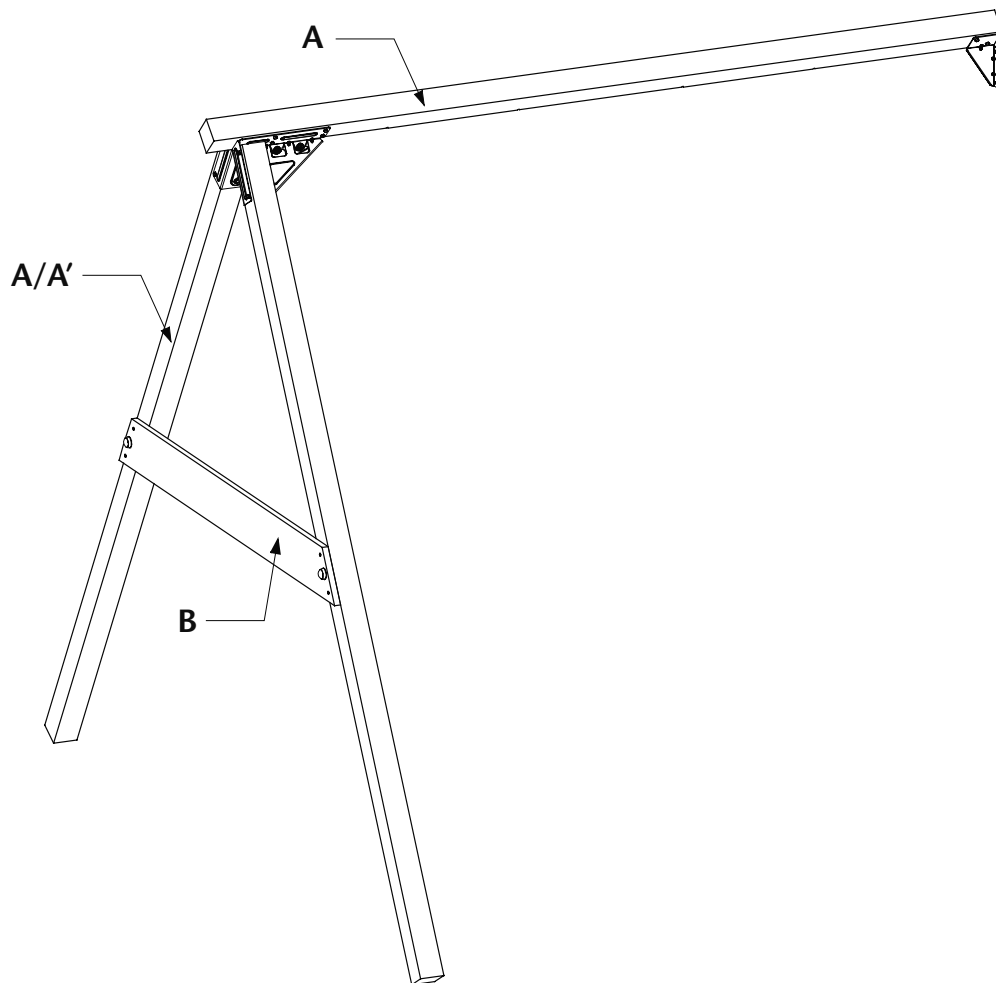

**CE**  
EN 71-1 71-8

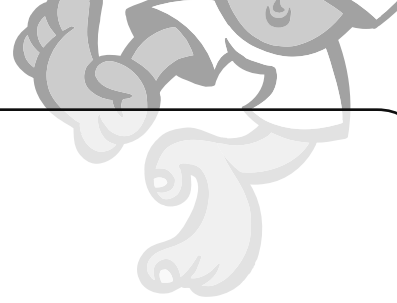

# Swing Module

**a**

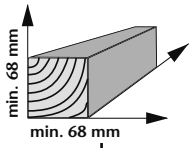

3x **A = 240 cm**

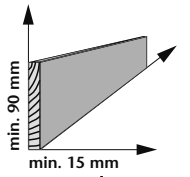

1x **B = 145 cm**

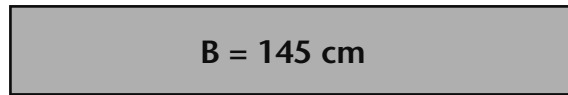

**b**

Swing Module + # 401.200 Jungle Tower

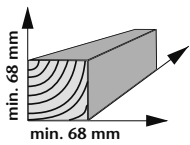

2x **A' = 210 cm**



1x **A = 240 cm**

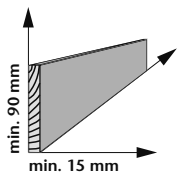

1x **B = 145 cm**

